



## FAQ

Frequently asked questions

---

### MXS Strada: connect and configure alarm LEDs



## Sensors

# 1 – MXS Strada: connect and configure alarm LEDs

---







### Question:

How can I activate my MXS Strada (Street Icons version) alarm LEDs so to answer my car/bike signals?

### Answer:

MXS Strada alarm LEDs are not strictly connected to a device analog input: they can be freely matched to analog/digital inputs and to data communication lines (OBDII, CAN, K-line, RS232).

MXS Strada – Street Icons version available icons are:

- direction lights 
- high beams 
- low beams 
- fuel reserve 
- oil pressure and oil level 
- water temperature 

In the following pages the physical connection with the related wiring diagrams and the software configuration of all alarm LEDs/icon of MXS Strada – Street Icons version are explained.

## Sensors

# 2 – Physical connection

Here follow explanation of all alarm LEDs/Icons physical connection.

## 2.1 – Direction lights and high/low beams LEDs/Icon

Lights and arrows alarm LEDs/Icon are 0-12V signals that control the original vehicle dashboard. Sometimes it is possible that this data is available via CAN bus (to verify it check the list of the channels available through your vehicle CAN driver).

### Direction lights:

- take the direction lights signal from the original dashboard connector
- connect it to Pin1 of one of the Binder connectors dedicated to MXS Strada analog inputs on 23 pins connector optional harness or directly to MXS Strada analog inputs

If the alarms for right and left arrows are different **be sure to** match the two channels together. To do this use two diodes (**1N4148**) as in the diagram below:



## Sensors

### High beams/Low beams:

- take the high/low beams signal from the original dashboard connector
- connect it to Pin1 of one of the Binder connectors dedicated to MXS Strada analog inputs on 23 pins connector optional harness or directly to MXS Strada analog inputs

High/Low beam  
0-12 V input

To pin1 of Binder connector  
(optional 23 pins connector harness)



Sensors

## 2.2 – Fuel LED/Icon

Reserve alarm LED/Icon can be associated to an analog channel coming from the fuel float or to a reserve sensor (very common on bikes without fuel level alert). Sometimes it is possible that this data is available via CAN Bus (to verify it check the list of the channels available through your vehicle CAN driver).

**Fuel level:** to connect the float you can use the fuel pump connector – where the sensor pins are available – or the original dashboard connector. Make the connection following the diagram below.

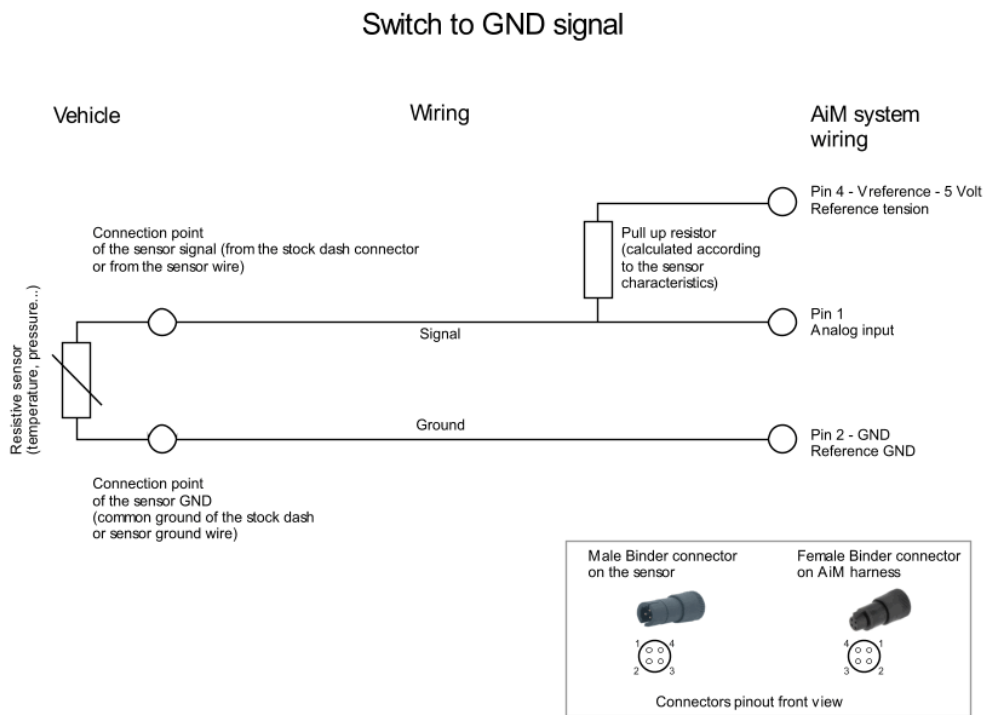

If the fuel level signal is taken from the original dashboard connector, it is possible that the sensor ground wire (GND) is not available: in this case connect the common ground of the vehicle connector to one of MXS Strada analog ground inputs or to pin2 of one of the Binder connectors dedicated to MXS Strada analog inputs on 23 pins connector optional harness.

**Sensors**

The pull-up resistance is to be bridge connected between a Vref (pin4 of one of the Binder connectors dedicated to MXS Strada analog inputs on 23 pins connector optional harness) and the analog input (pin1 of the same Binder connector) already used to take the signal coming from the sensor.

To correctly adjust the pull-up resistance, measure the resistance values corresponding to full and empty tank (with vehicle switched off), multiply the higher one by 9 and find the pull-up resistance value to be used. Should this value not correspond to an available resistance choose a resistance whose value is rounded off by excess.

**Fuel reserve alarm:** to connect to a fuel reserve alarm (ON/OFF switch) you can use the fuel pump connector, where the sensor pins are, or the original dashboard connector. Make the connection following the diagram below.

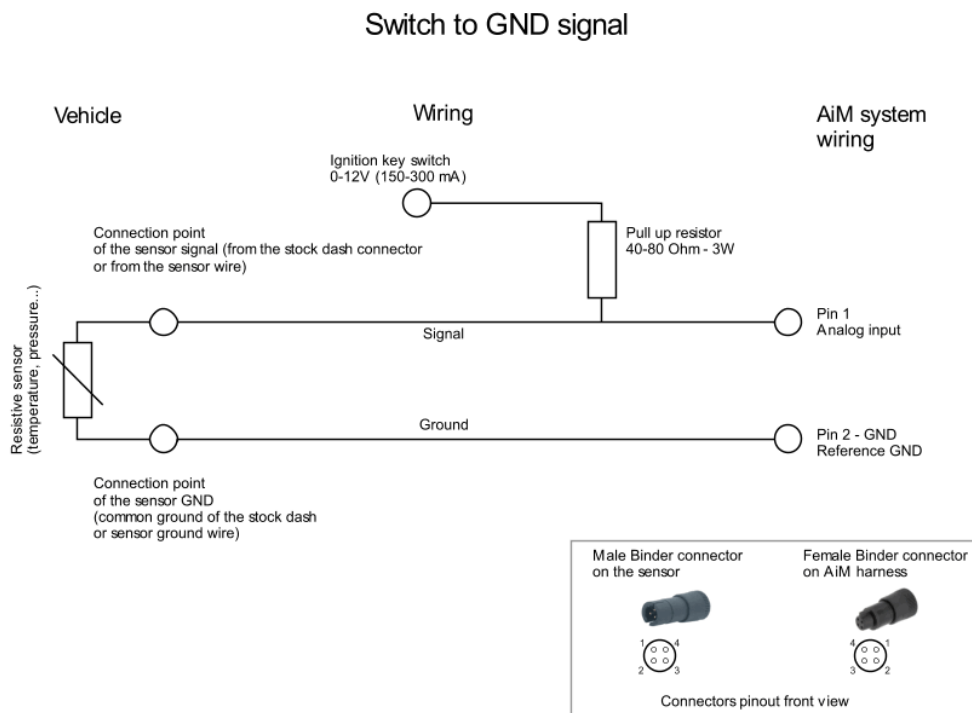

If the fuel level signal is taken from the original dashboard connector, it is possible that the sensor ground wire (GND) is not available. In this case, connect the common ground of the vehicle connector, to one of MXS Strada analog ground inputs or to pin2 of one of the Binder connectors dedicated to MXS Strada analog inputs on 23 pins connector optional harness.

**Sensors**

## 2.3 – Oil pressure/level LED/Icon:

Oil alarm LED/icon can be associated to a digital ON/OFF command (switched to ground), to a pressure sensor among the available ones in the AiM catalogue or to data transmitted via CAN bus (to verify it check the list of the channels available through your vehicle CAN driver).

**Oil pressure/level alarm LED/icon:** to connect an oil pressure/level signal to MXS Strada, use the original dashboard connector, where are the signal pins. Make the connection following the diagram below.

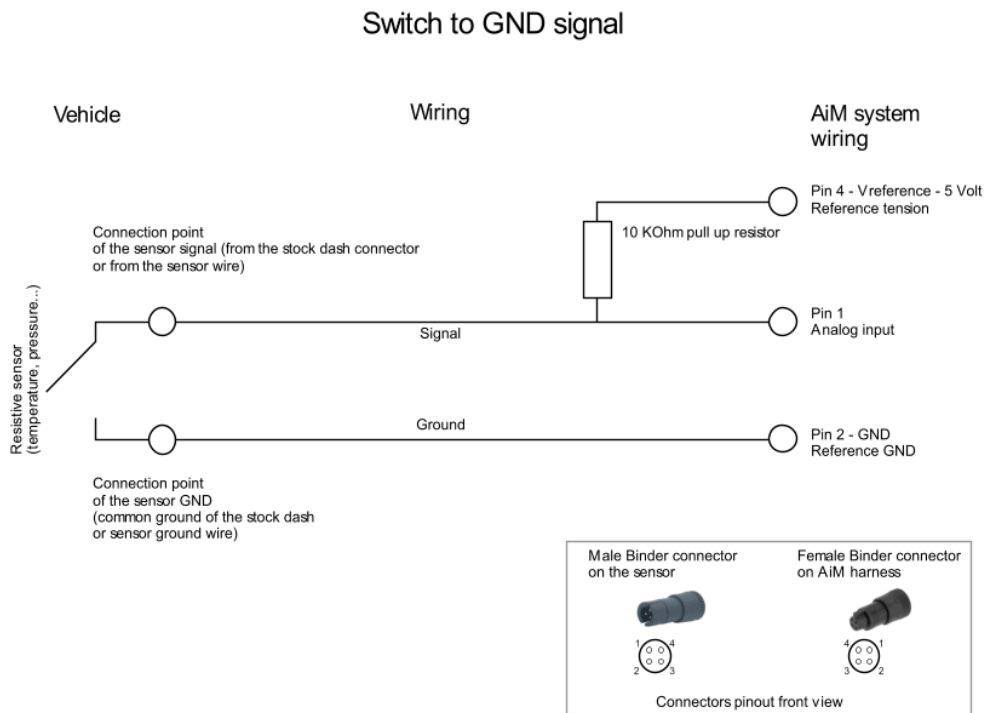

**AiM oil pressure sensor:** connect the sensor to one of the Binder connectors dedicated to MXS Strada analog inputs on 23 pins connector optional harness. If using a customized harness, be sure to connect signal, ground and Vref (5V) or Vbat (12V) power – according to the sensor you choose. For further information about the AiM available sensor check the sensors documentation on download area of our website [www.aim-sportline.com](http://www.aim-sportline.com).

**If using the vehicle on-board sensors be sure** to know their connection diagram and their characteristic curve to correctly connect it to MXS Strada and fill its curve values in Race Studio 3 custom sensors menu.



## Sensors

### 2.4 – Water temperature LED/Icon:

---

Water LED/Icon can be associated to a water temperature sensor among these available in AiM catalogue or to a data transmitted via CAN bus (to verify it check the list of the channels available through your vehicle CAN driver).

**AiM water temperature sensor:** connect the sensor to one of the Binder connectors dedicated to MXS Strada analog inputs on 23 pins connector optional harness. If using a customized harness, be sure to connect signal, ground and Vref (5V) power. For further information about the AiM available sensor check the sensors documentation on download area of our website [www.aim-sportline.com](http://www.aim-sportline.com).

**If using the vehicle on-board sensors be sure** to know their connection diagram and their characteristic curve to correctly connect it to MXS Strada and fill its curve values in Race Studio 3 custom sensors menu.



## Sensors

# 3 – Race Studio 3 configuration

To configure the signals received by MXS Strada using RS3, proceed as explained below:

- run Race Studio 3
- connect MXS Strada to the PC through the proper USB cable
- click “Configurations” ( ): the section main page appears; Connected Devices list (lower left corner of the page) shows your MXS Strada connected
- to create a new configuration, click “New”, select “MXS Strada”, fill in a name and a comment (optional) for the configuration and click “OK”
- to modify an existing configuration, double click on it.

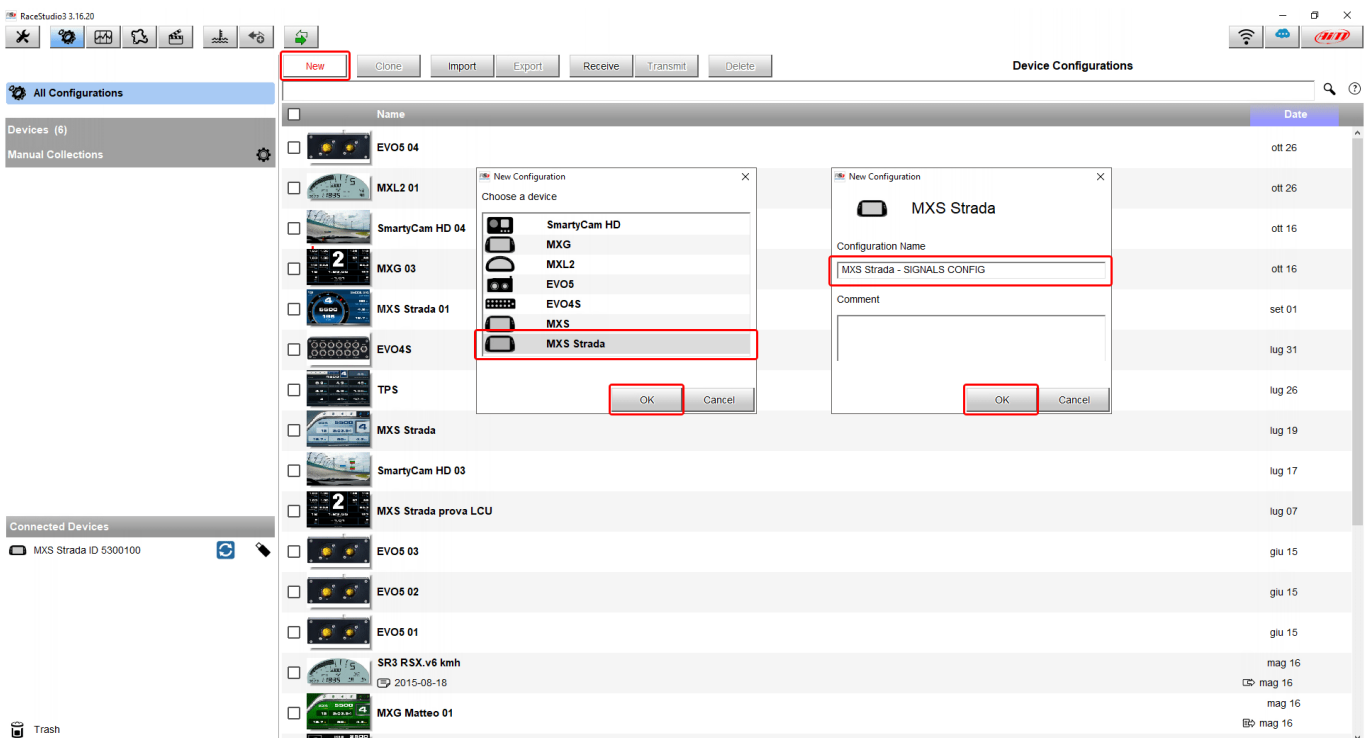

By default the software enters “Channels” tab of the selected configuration which shows all the device channels with their functions.

**Sensors**

**3.1 – Direction lights and high/low beams icons:**



To configure direction lights and high/low beams alarm LEDs/icon you need to:

- create a custom sensor
- associate it to one of MXS Strada analog inputs
- configure the alarms LED in “Shift Lights and Alarms” tab

**Create a custom sensor:**

- click “Custom sensor” (  ) on the software tip keyboard
- in the page that appears click “New” to create a new sensor
- fill in the panel that appears with a name (in the example “Dir. Lights”) and a comment (optional) and click “OK”.
- the window here below appears; set:
  - Measure Type: Number;
  - Calibration Type: None;
  - Input Type: mV
- fill in the table with the values in Mv corresponding to active signal (12.000 mV - 1.0) and inactive signal (0 mV - 0.0)
- click “Save” and the sensor you created appears in the available sensors list labelled as “Number”

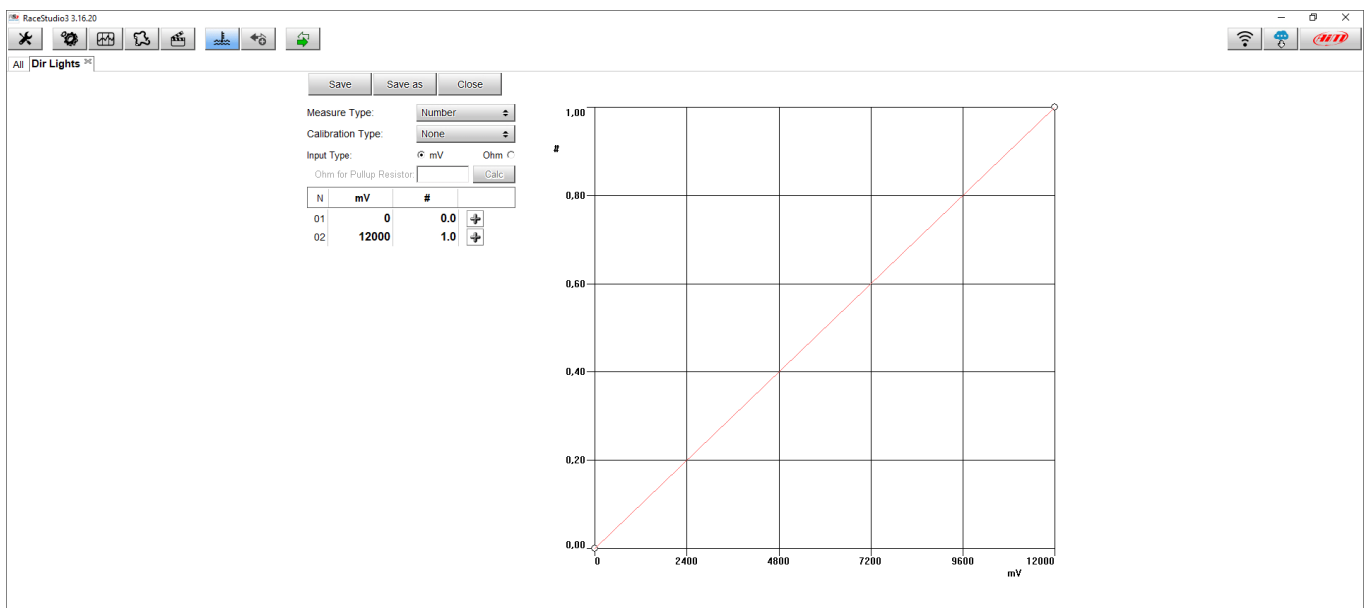

## Sensors

### Associate it to one of MXS Strada analog inputs:

- in “Channels” tab select the channels you want to set each LED/Icon on
- complete setting choosing “Number” function, “Number” sub-function and the sensor you have just created
- set “**Display Precision**” on “**1 decimal place**” (right image below) and press “Save” to save the sensor.

Proceed the same way for the three channels: high/low beams and arrows.

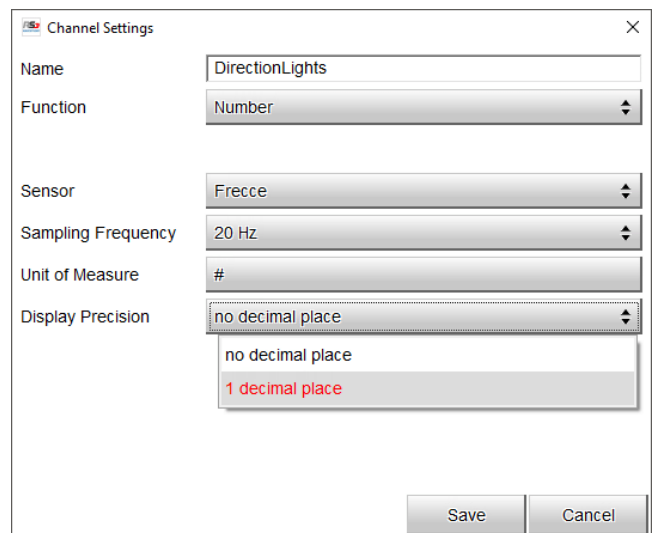
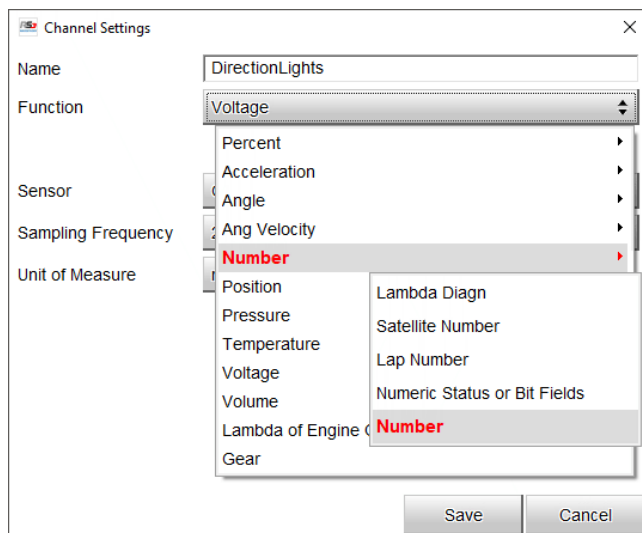

## Sensors

### Configure the alarms LED in “Shift Lights and Alarms” tab

- in “Shift Lights and Alarm” tab press “add New Alarm” to set a new alarm
- fill in its name, the channel to set it on and its threshold value; being this signals set as Number, the correct threshold value is 0.5 (#)
- be sure the channel is configured with one decimal place
- choose the LED that will show the signal and customize it (colour, blinking frequency ecc); LEDs functions should be:
  - LED1: direction lights
  - LED2: high beams
  - LED3: low beams.
- click “Save” to save the alarm

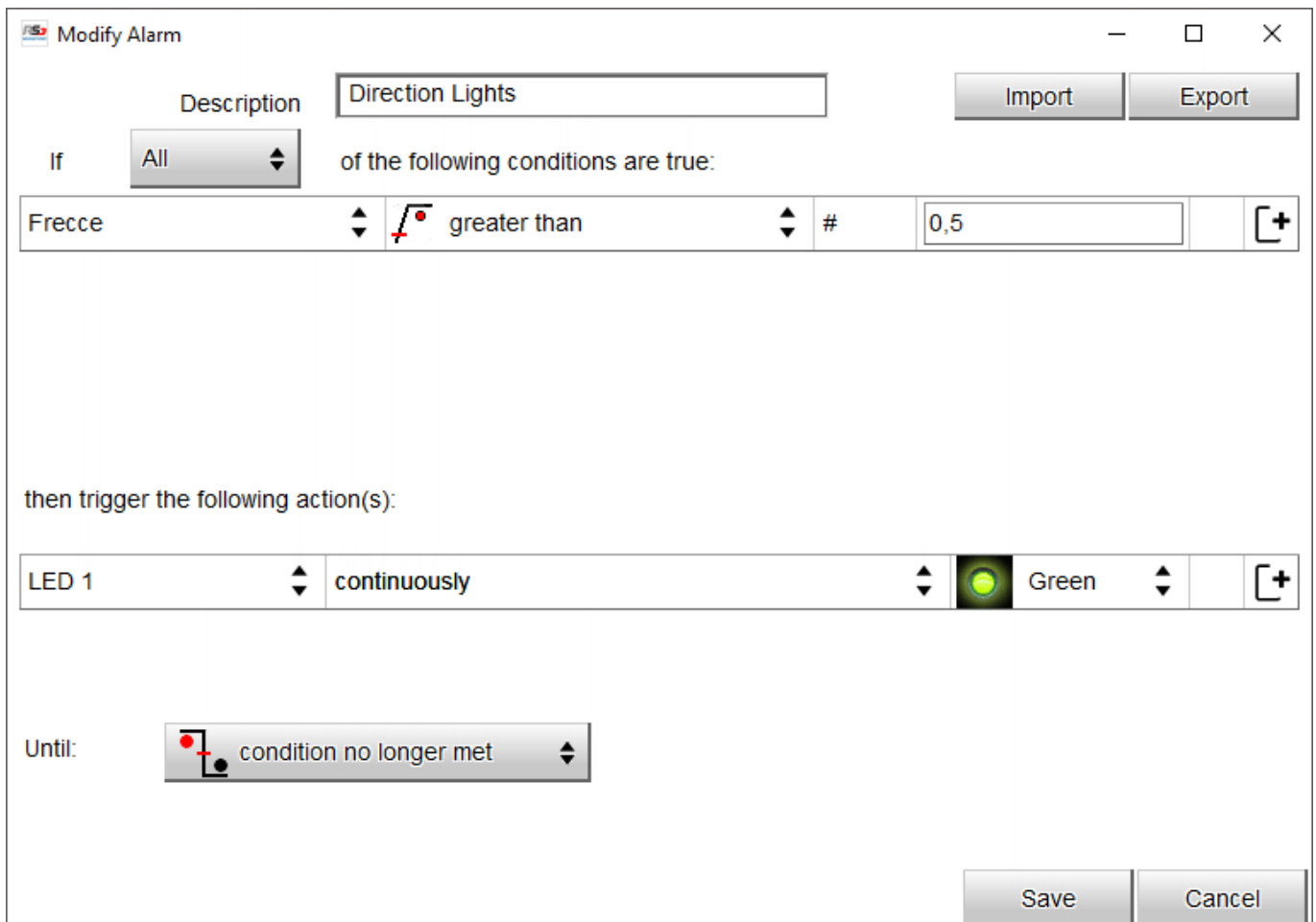

Modify Alarm

Description: Direction Lights

Import Export

If: All of the following conditions are true:

Freccce greater than # 0,5

then trigger the following action(s):

LED 1 continuously Green

Until: condition no longer met

Save Cancel

Sensors

### 3.2 – Fuel alerts icon:



To configure fuel level LED/icon you need to:

- using RS3 Live Measures function find the correspondence between the tension read by AiM device and the fuel tank level
- create a custom sensor
- associate it to one of MXS Strada analog inputs
- configure the alarms LED in “Shift Lights and Alarms” tab

**Using Live Measure function:**

- with the device switched on and connected press “Device” ( ) on the software top keyboard
- select the connected “MXS Strada”
- press “Live Measures” and take note of the tension values of **fuel level sensor** with the fuel tank full and with the fuel tank empty (tensions are shown clicking “Mv Values”); for a more accurate measurement perform the procedure adding fuel step by step and taking note of the detected values
- if using a “**fuel reserve sensor**” with no level indication, to have a more accurate measurement take note of the values read by the sensor with the fuel tank full and with it empty in a 5 minutes time period with the vehicle switched on; it is suggested to read the values with the battery fully charged and the engine started

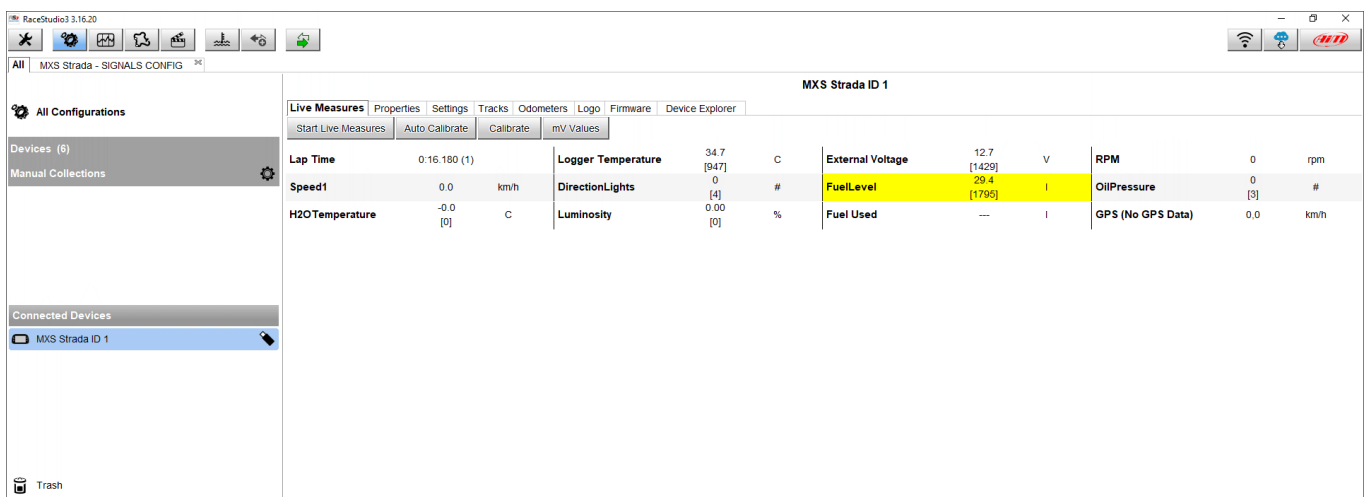

**Sensors**

**Create a custom sensor:**

- click “Custom sensor” ( ) on the software top keyboard
- in the page that appears click “New” to create a new sensor
- fill in the panel that appears with a name (in the example “Fuel LVL”) and a comment (optional) and click “OK”.
- the window here below appears; set:
  - Measure Type: Volume;
  - Calibration Type: None;
  - Input Type: Mv

**If using a fuel level sensor:**

- fill in the table with the values in Mv and the corresponding fuel litres (you can choose the measure unit in litres or gallons)
  - click “Save” and the sensor you created appears in the available sensors list labelled as “Volume”.
- Please note:** “Fuel level” function can also be expressed in percentage (“Pct Fuel Level”): in this case choose the voltage corresponding to the different filling percentages.

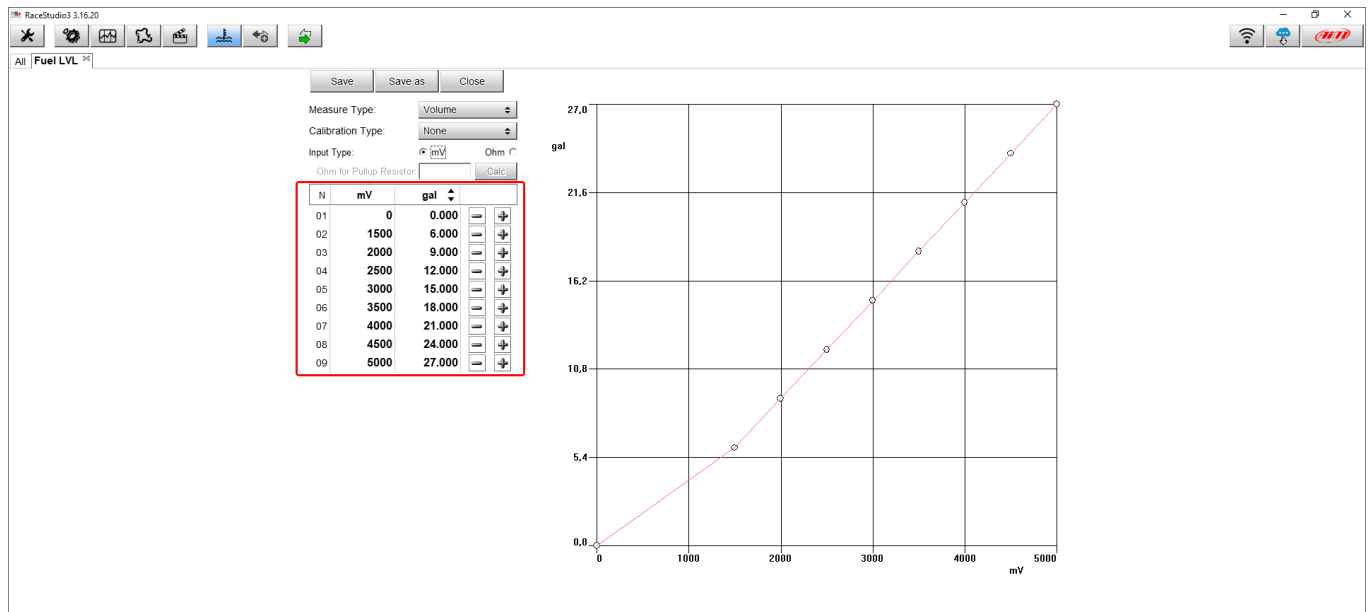

**If using a fuel reserve sensor:**

- in the windows shown here above set:
  - Measure Type: Number;
  - Calibration Type: None;
  - Input type: mV;
- fill in the table with the values in mV corresponding to empty tank (1.0) and full tank (0.0)
- click “Save” and the sensor you created appears in the available sensors list labelled as “Number”

## Sensors

### Associate it to one of MXS Strada analog inputs:

If using a **fuel level sensor**:

- in "Channels" tab choose the channel to set the fuel level on
- complete its settings choosing "Volume" function and "Fuel Level" sub-function as in the example below or "Percent" function, "Pct Fuel Level" sub-function and the sensor you just created
- press "Save" to save the sensor

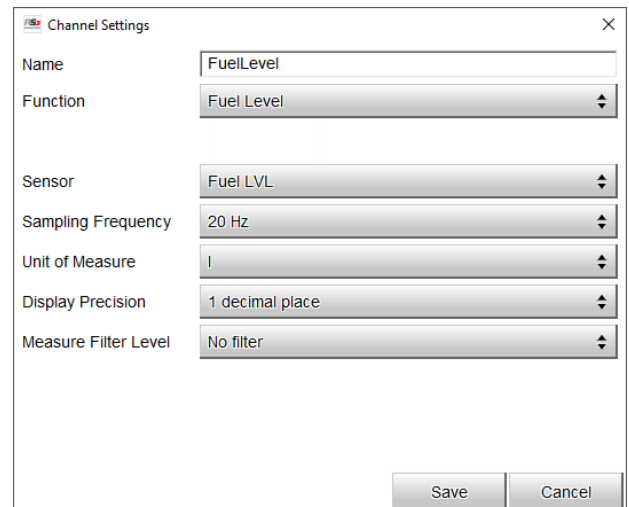
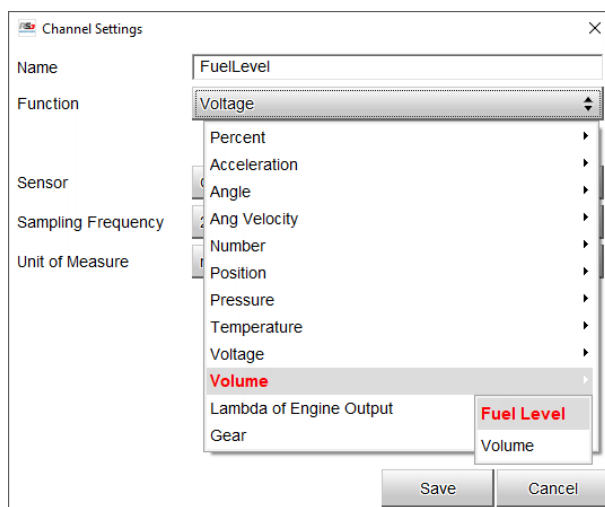

If using a **fuel reserve sensor**:

- complete its settings choosing "Number" function, "Fuel Level" sub-function and the sensor you just created
- set "**Display precision**" on "**1 decimal place**" (right image below) and press "Save"

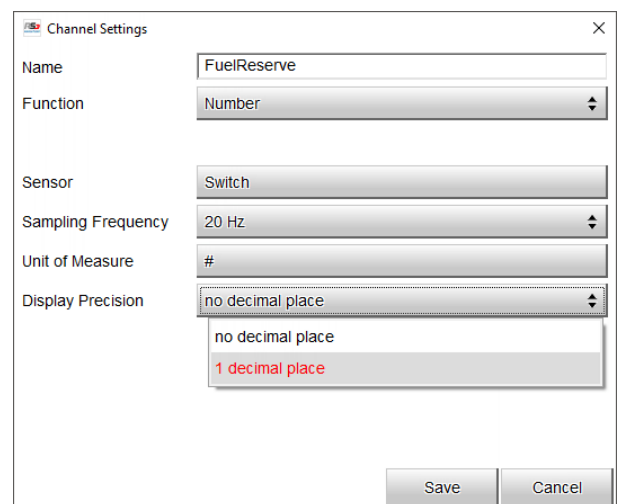
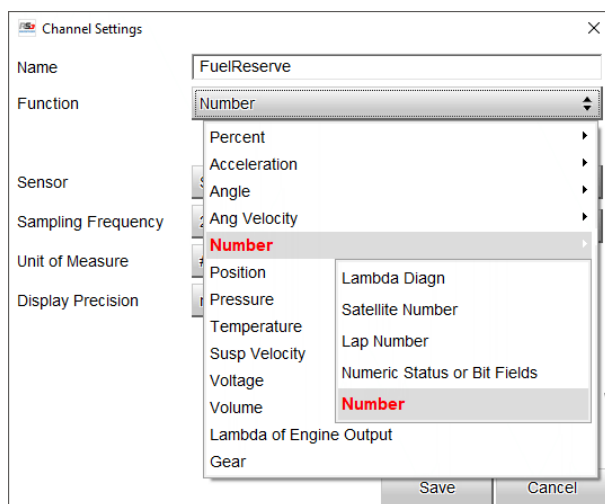

## Sensors

### Configure the alarms LED in “Shift Lights and Alarms” tab

- in “Shift Lights and Alarm” tab press “add New Alarm” to set a new alarm
- fill in its name, the channel to set it on (analog or CAN) and its threshold value under whom the LED/Icon switches on; the threshold value refers to the fuel litres/gallons or to the percentage according to the function you set.

If using a **Fuel reserve sensor** set threshold value higher than 0.5: be sure that the channel is configured with one decimal place

- choose the LED that will switch on (LED4) and its working mode (colour, blinking frequency etc)
- click “Save” to save the alarm

The screenshot shows the 'Modify Alarm' dialog box with the following configuration:

- Description:** Fuel LVL
- If:** All of the following conditions are true:
- Condition:** LivelloCarbur less than 7.0
- then trigger the following action(s):** LED 4 continuously Yellow
- Until:** condition no longer met
- Buttons:** Save, Cancel

The screenshot shows the 'Modify Alarm' dialog box with the following configuration:

- Description:** Fuel Reserve
- If:** All of the following conditions are true:
- Condition:** RiservaCarbur greater than 0.5
- then trigger the following action(s):** LED 4 continuously Yellow
- Until:** condition no longer met
- Buttons:** Save, Cancel



## Sensors

### 3.3 – Oil pressure/level icon:

To configure the oil pressure/level LED/Icon you need to:

- create a custom sensor
- associate it to one of MXS Strada analog inputs
- configure the alarms LED in “Shift Lights and Alarms” tab

#### Create a custom sensor:

- click “Custom sensor” () on the software top keyboard
- in the page that appears click “New” to create a new sensor
- fill in the panel that appears with a name (in the example “Oil Press”) and a comment (optional) and click “OK”.
- the window here below appears; set:
  - Measure Type: Number;
  - Calibration Type: None;
  - Input Type: Mv
- fill the table with the values in Mv corresponding to closed circuit – low oil pressure (0 mV – 1.0) and to open circuit – oil in pressure (5.000 mV – 0.0)
- click “Save” and the sensor you created appears in the available sensors list labelled as “Number”

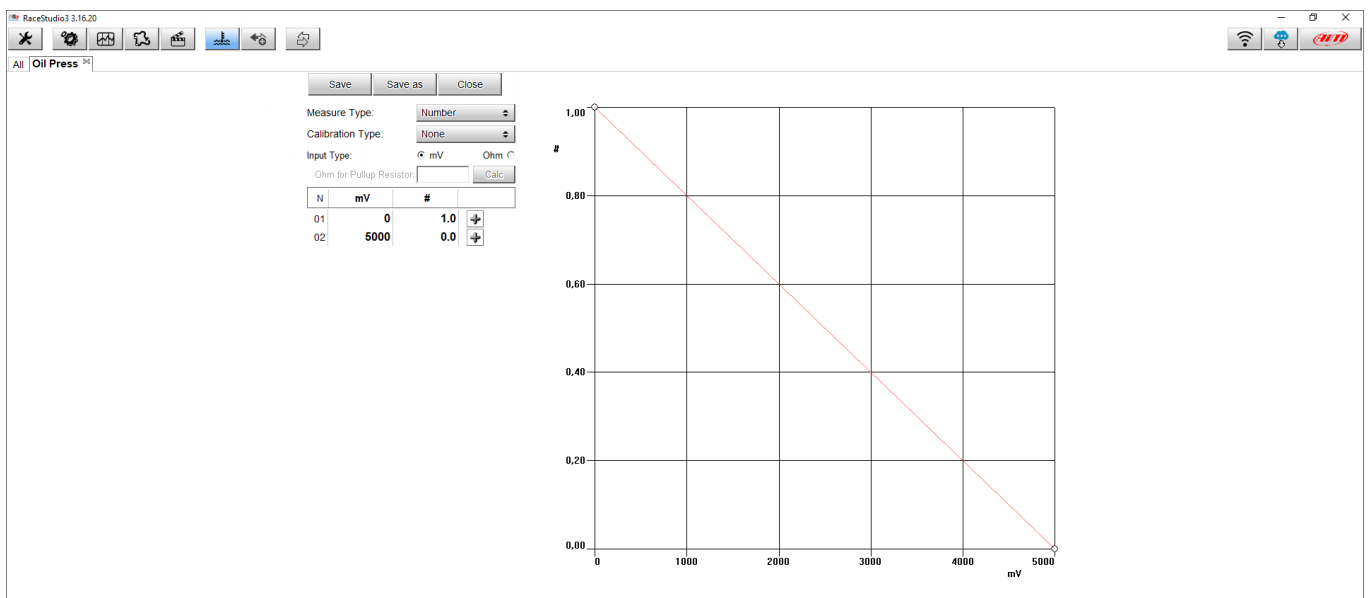

The screenshot shows the 'Oil Press' configuration window in RaceStudio3. The window has a title bar with 'RaceStudio3 3.16.20' and standard OS window controls. Below the title bar are 'Save', 'Save as', and 'Close' buttons. The configuration panel includes:

- Measure Type: Number
- Calibration Type: None
- Input Type: mV (selected), Ohm
- Ohm for Pullup Resistor: (empty field) Calc

A table below the configuration panel defines the sensor's response:

N	mV	#
01	0	1.0
02	5000	0.0

To the right of the table is a graph with a grid. The x-axis is labeled 'mV' and ranges from 0 to 5000. The y-axis is labeled '#' and ranges from 0.00 to 1.00. A red line connects the points (0, 1.00) and (5000, 0.00), representing the sensor's calibration curve.

## Sensors

As already specified, in case of stock **oil pressure sensors**, you need to know its physical connection and the characteristic curve that defines the voltage corresponding to a pressure value to show correct values. To read and manage these sensors you need to create a custom sensor in the table of each fill in the known, setting then the sensor as follows:

- Measure Type: Pressure;
- Calibration Type: None;
- Input type: mV.

### Associate it to one of MXS Strada analog inputs:

- in "Channels" tab select the channels you want to set each LED/Icon on
- complete setting choosing "Number" function, "Number" sub-function and the sensor you have just created
- if using an **AIM pressure sensor** select "Pressure" function, "Oil Pressure" sub-function and the sensor you are using
- if using a stock sensor select the custom sensor you have just created
- set "Display Precision" on "1 decimal place" (right image below)
- press "Save" to save the sensor.

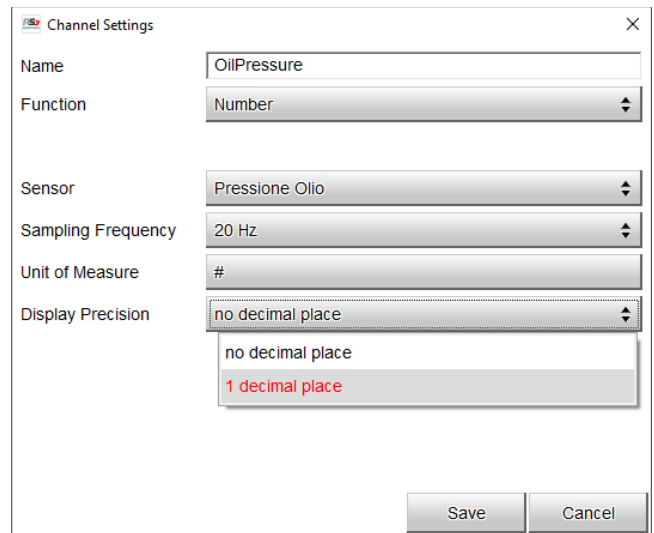
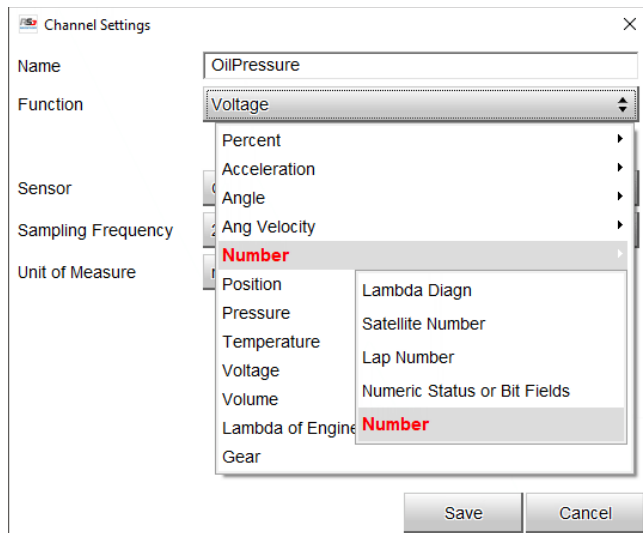

## Sensors

### Configure the alarms LED in “Shift Lights and Alarms” tab

- in “Shift Lights and Alarm” tab press “add New Alarm” to set a new alarm
- fill in its name, the channel to set it on and its threshold value; being this signals set as Number, the correct threshold value is 0.5 (#)
- be sure the channel is configured with one decimal place
- choose the LED that will show the signal (LED5) for oil pressure and customize it (colour, blinking frequency ecc)
- if using AiM pressure sensor or stock sensors or for data received via CAN bus, RS232, K-Line the LED/Icon threshold is to set as min, for example for values lower than 1 bar
- click “Save” to save the alarm

Modify Alarm

Description: OilPress

Import Export

If: All of the following conditions are true:

OilPressure		greater than	#	0,5	+
-------------	--	--------------	---	-----	---

then trigger the following action(s):

LED 5	continuously		Red	+
-------	--------------	--	-----	---

Until: condition no longer met

Save Cancel

## Sensors

### 3.4 – Water temperature icon:



To configure water temperature LED/icon it is suggested to use AiM temperature sensors (PT100 thermo-resistor) or, if available, the information coming from the ECU data or diagnosis line (CAN bus, RS232, K-Line).

If using on-board sensors you need to:

- using RS3 Live Measures function find the correspondence between the tension read by AiM device and the fuel tank level
- create a custom sensor

The following steps are the same for AiM sensor and stock ones

- associate it to one of MXS Strada analog inputs
- configure the alarms LED in “Shift Lights and Alarms” tab

#### Using Live Measure function:

- with the device switched on and connected press “Device” () on the software top keyboard
- select the connected “MXS Strada”
- press “Live Measures” and take note of the tension values of **water temperature sensor** corresponding to the measured temperatures (tensions are shown clicking “Mv Values”); for a more accurate measurement perform the procedure when the circuit is cooling down noting them step by step (for example 5-10 degrees at a time).

## Sensors

### Create a custom sensor:

- click “Custom sensor” (  ) on the software top keyboard
- in the page that appears click “New” to create a new sensor
- fill in the panel that appears with a name (in the example “H2O Temperature”) and a comment (optional) and click “OK”.
- the window here below appears; set:
  - Measure Type: Temperature;
  - Calibration Type: None;
  - Input Type: Mv
- fill the table with the values you registered before (you can choose among °C and °F)
- when an acceptable data number is reached click “Save” and the sensor you created appears in the available sensors list labelled as “Temperature”

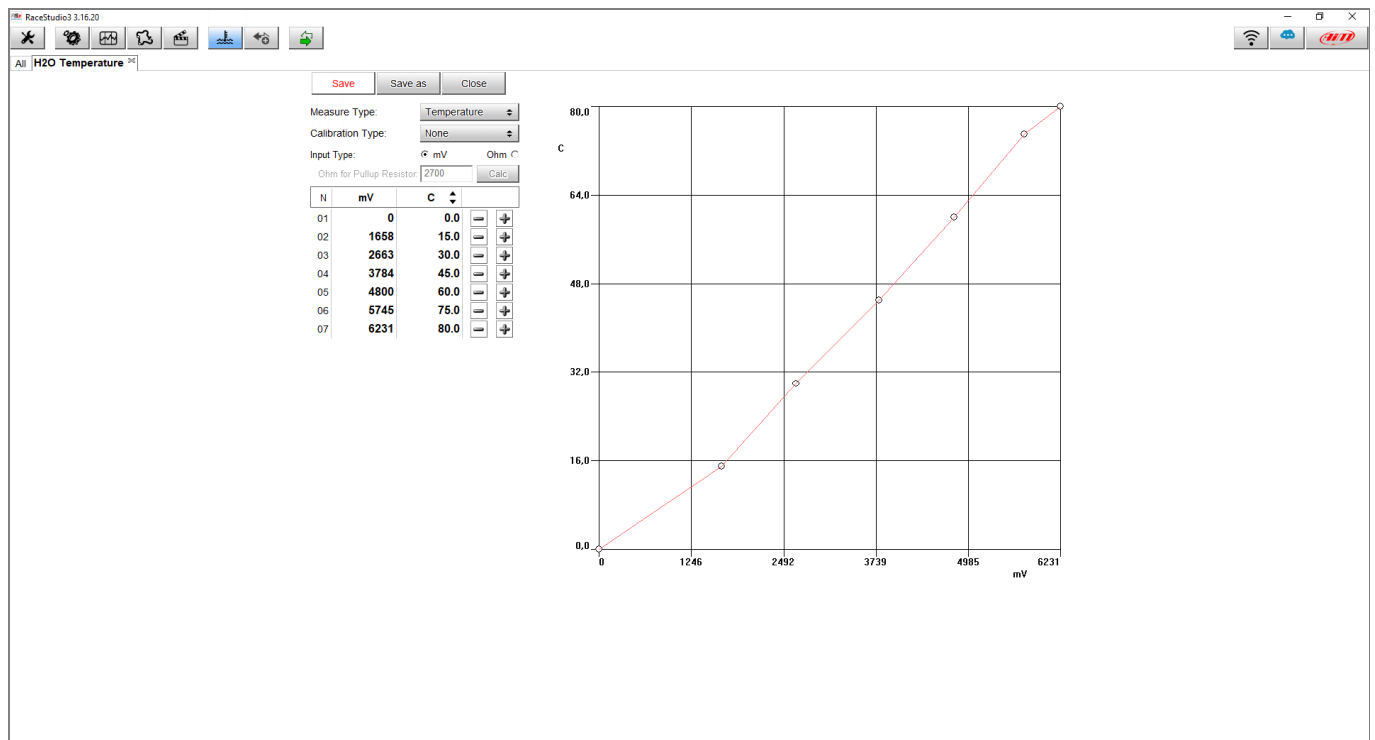

## Sensors

### Associate it to one of MXS Strada analog inputs:

- in “Channels” tab select the channels you want to set each LED/Icon on
- complete setting choosing “Temperature” function, “Water Temp” sub-function and the sensor you are using (AiM PT-100 in the right image below) or the custom sensor you have just created
- press “Save” to save the sensor.

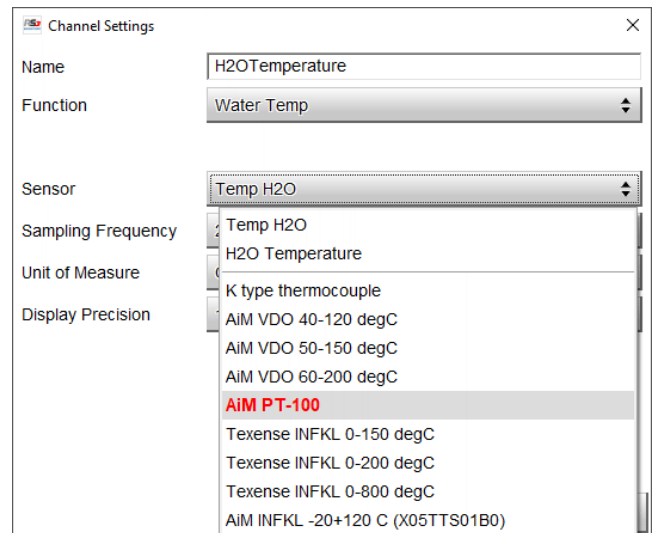
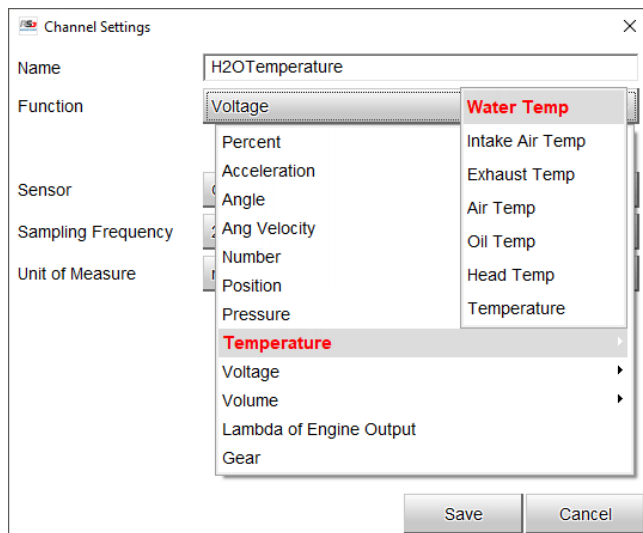

## Sensors

### Configure the alarms LED in “Shift Lights and Alarms” tab

- in “Shift Lights and Alarm” tab press “add New Alarm” to set a new alarm
- fill in its name, the channel to set it on and its max threshold value (for example >105°C or 221>°F)
- choose the LED that will show the signal (LED6) for water temperature and customize it (colour, blinking frequency etc.)
- click “Save” to save the alarm

Modify Alarm

Description: High H2OTemp

Import Export

If: All of the following conditions are true:

H2OTemperature	greater than	C	105,0	[+]
----------------	--------------	---	-------	-----

then trigger the following action(s):

LED 6	continuously	Red	[+]
-------	--------------	-----	-----

Until: condition no longer met

Save Cancel